

# APPROVAL

PART NO.	DESCRIPTION	REMARKS
<b>HT3503L-T</b>	<b>LCD MODULE</b> (320 × RGB × 240) With Touch Screen	* <b>This is ROHS compliant</b>

CUSTOMER APPLICATION P/N	
APPROVED BY	
DATE	

PLEASE KINDLY FIND AND APPROVE THE SPECIFICATIONS INSERTED  
HEREIN AND RETURN ONE COPY HERE OF WITH YOUR SIGNATURE OF APPROVAL.

PERPARED BY	CHECKED BY	CONFIRMED BY



**HYES Optoelectronics, Inc.**

2000 Wyatt Drive Suite 6  
Santa Clara, CA 95054 USA

## CONTENTS:

No.	Item
1	<b>BASIC SPECIFICATION</b> 1.1 Mechanical Specification 1.2 Display Specification 1.3 Outline Dimension 1.4 Block Diagram 1.5 Interface Pin
2	<b>ELECTRICAL CHARACTERISTICS</b> 2.1 Absolute Maximum Ratings 2.2 DC Characteristics 2.2.1 Back-light 2.3 AC Characteristics
3	<b>OPTICAL CHARACTERISTICS</b> 3.1 Condition 3.2 Definition of Optical Characteristics
4	<b>RELIABILITY</b>
5	<b>PRODUCT HANDING AND APPLICATION</b>
6	<b>DATECODE</b>
7	<b>PACKING &amp; LOTNO</b>
8	<b>INSPECTION STANDARD</b>

Date : Oct. 03, 2007

TECHNICAL SPECIFICATION

**HYES**

LCM

HT3503L-T

Page 2 of 23

## 1. BASIC SPECIFICATION

### 1.1 Mechanical specifications

Items	Nominal Dimension	Unit
Dot Matrix	320*RGB*240	dots
Module Size (W x H x T)	76.9 x 63.9 x 3.2	mm
Active Area (W x H)	70.08 x 52.56	mm
Dot Pitch (W x H)	0.219 x 0.219	mm
Driving IC Package	COG	

\* Expose the driver IC under blaze (luminosity over than 1 cd) when using the LCM may cause IC operating failure.

### 1.2 Display specification

Display	Descriptions	Note
LCD Type	3.5" TFT	
LCD Mode	Normally White	
Polarizer Mode	Transmissive	
Polarizer UV - Cutting	With	
Polarizer Surface	Normal	
Background Color	White	
Backlight Type	LED	
Backlight Color	White	
Viewing Direction	6 O'clock Direction	

\* Color tone is slightly changed by temperature and driving voltage.

# 1.3 Outline dimension

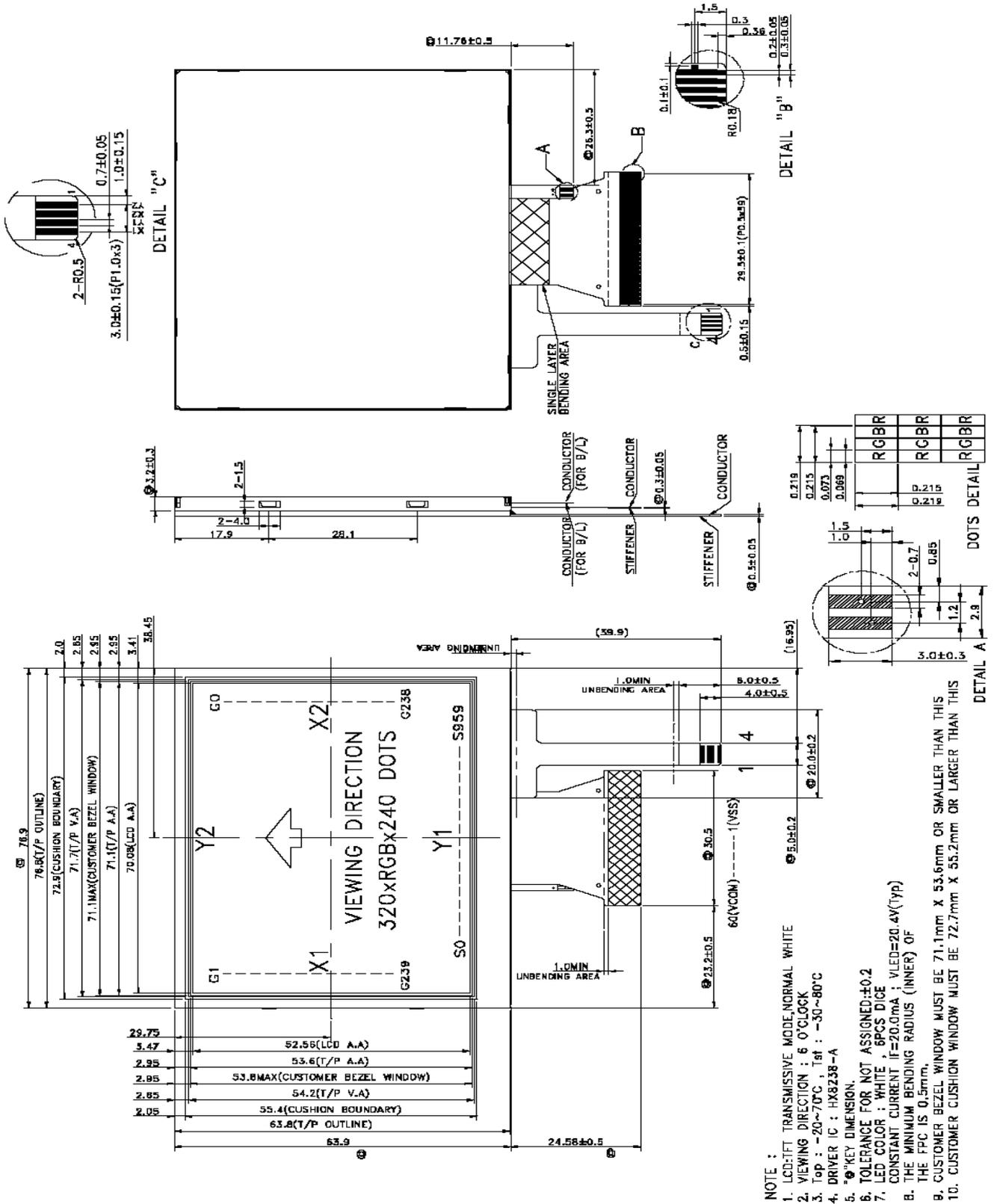

Date : Oct. 03, 2007

TECHNICAL SPECIFICATION



LCM

HT3503L-T

Page 4 of 23



### 1.5 Interface pin :

Pin No.	Pin Name	I/O	Description
1	<b>VSS</b>	<b>P</b>	System ground pin of the IC. - Connect to system ground
2	<b>POL</b>	<b>O</b>	Polarity signal to monitor VCOM signal.
3	<b>RES</b>	<b>I</b>	System reset pin. Internal pull high.
4	<b>CSB</b>	<b>I</b>	Chip select pin of serial interface. Internal pull high. - Leave it OPEN when not used.
5	<b>SCK</b>	<b>I</b>	Clock pin of serial interface. Internal pull high. - Leave it OPEN when not used
6	<b>SDI</b>	<b>I</b>	Data input pin in serial mode. Internal pull high. - Leave it OPEN when not used
7~30	<b>BB [0:7]</b> <b>GG [0:7]</b> <b>RR [0:7]</b>	<b>I</b>	Graphic Data Input Pins. Internal pull low. - RR [0:7]: Red Data - 8-bits - GG [0:7]: Green Data - 8-bits - BB [0:7]: Blue Data - 8-bits For 8 bit interface, only RR[0:7] are used. For unused pins, please connect to VSS or floating.
31	<b>DEN</b>	<b>I</b>	Display enable pin from controller.
32	<b>HSYNC</b>	<b>I</b>	Line synchronization signal. Internal pull high - Fixed to VCI or floating if not used
33	<b>VSYSNC</b>	<b>I</b>	Frame synchronization signal. Internal pull high. - Fixed to VCI or floating if not used.
34	<b>DOTCLK</b>	<b>I</b>	Dot-clock signal and oscillator source.
35	<b>SDO</b>	<b>O</b>	Data output pin in serial mode. - Leave it OPEN when not used
36	<b>TB</b>	<b>I</b>	Input pin to select the Gate driver scan direction. - Connect to VSS for Gate scan from G239 to G0 (reverse scan) - Connect to VCI for Gate scan from G0 to G239 (normal scan)
37	<b>RL</b>	<b>I</b>	Input pin to select the Source driver data shift direction. - Connect to VCI for display first RGB data at S0-S2. - Connect to VSS for display first RGB data at S959-S957.
38	<b>VCI</b>	<b>O</b>	Negative voltage of VCI. - Connect a capacitor for stabilization.

Date : Oct. 03, 2007

TECHNICAL SPECIFICATION

**HYES**

LCM

HT3503L-T

Page 6 of 23

Pin No.	Pin Name	I/O	Description
39	CIP	I	Connect a capacitor to CIN.
40	CIN	I	Connect a capacitor to CIP.
41	VLCD63	O	Internal generated power for source driver. - Connect a capacitor for stabilization.
42	VCIX2J	P	This is the power supply used by on chip analog blocks and VGH/VGL.
43	VCIX2	O	Equals to 2 x VCI. Connect a capacitor for stabilization.
44	CYN	I	Connect a capacitor to CYP.
45	CYP	I	Connect a capacitor to CYN.
46	CXN	I	Connect a capacitor to CXP.
47	CXP	I	Connect a capacitor to CXN.
48	VCI	P	Power Supply for Analog Circuits.
49	VDD	P	Power Supply for Logic Circuits.
50	CN	I	Connect a capacitor to CP.
51	CP	I	Connect a capacitor to CN.
52	VGL	O	A negative power output pin for gate driver.
53	C2N	I	Connect a capacitor to C2P.
54	C2P	I	Connect a capacitor to C2N.
55	C3N	I	Connect a capacitor to C3P.
56	C3P	I	Connect a capacitor to C3N.
57	VGH	O	A positive power output pin for gate driver.
58	VOOML	O	This pin indicates a LOW level of VOOM generated in driving the VOOM alternation. - Connect a capacitor for stabilization.
59	VOOMH	O	This pin indicates a HIGH level of VOOM generated in driving the VOOM alternation. - Connect a capacitor for stabilization.
60	VOOM	O	A power supply for the TFT-display common electrode.

**Backlight pin:**

1	K	P	Backlight LED <sup>+</sup> s cathode.
2	A	P	Backlight LED <sup>+</sup> s anode.

**Touch screen panel pin:**

1	X1	-	Touch screen
2	Y1	-	Touch screen
3	X2	-	Touch screen
4	Y2	-	Touch screen

Date : Oct. 03, 2007

TECHNICAL SPECIFICATION

**HYES**

LCM

HT3503L-T

Page 7 of 23

## 2. ELECTRICAL CHARACTERISTICS

### 2.1 Absolute Maximum Ratings

Items	Symbol	Min.	Max.	Unit
Power supply voltage	VDD	-0.3	2.7	V
Power supply voltage	VDDIO	-0.3	4.0	V
Input voltage	VCI	VSS-0.3	5.0	V
Operate temperature range	T <sub>OP</sub>	-20	70	°C
Storage temperature range	T <sub>ST</sub>	-30	80	°C



## 2.2 DC Characteristics

Items	Symbol	Min.	Typ.	Max.	Unit	Condition
Power supply voltage	V <sub>CC</sub>	3.0	3.3	3.6	V	
Current for Driver	I <sub>VCC</sub>	TBD	TBD	TBD	mA	V <sub>CC</sub> =3.3V

\*NOTE1: If change the VDD, the voltage boost and contrast need to be set again.

\*NOTE2: Min. and Max. Voltage is mean within the range will has optimum contrast at Ta:25°C

Typ. Voltage is specified as module driving condition: Ta=25°C, V<sub>OP</sub> at Optimum Contrast.  
the measuring condition as below, this value is **HYES** recommend when customer change the set condition, the V<sub>LCD</sub> will be change.

NOTE2 :

Measuring Condition :

Standard Value MAX

Ta = 25°C

V<sub>CC</sub> = 3.3V

Display Pattern = Checkered pattern

### 2-2.1 Back-light Characteristics

PARAMETER	SYMBOL	MIN	TYP	MAX	Unit	Test Condition	NOTE
Supply Current	I <sub>f</sub>	-	20	-	mA	Ta=25°C	-
Supply Voltage	V <sub>F</sub>	-	20.4	--	V	Ta=25°C	-
Brightness	Br	2550	3150	--	cd/m <sup>2</sup>	Ta=25°C I <sub>f</sub> =20mA	8
Half-Life Time	L <sub>f</sub>	-	10000	-	hrs	Ta=25°C	9

Note 8 : Back-light only.

Note 9 : The " Half-Life Time "is defined as the module brightness decrease to 50% original brightness

Date : Oct. 03, 2007

TECHNICAL SPECIFICATION

**HYES**

LCM

HT3503L-T

Page 9 of 23

## 2-3 AC Characteristics

### AC Characteristics

(Unless otherwise specified, Voltage Referenced to V<sub>SS</sub>, V<sub>DDIO</sub> = 2.2V, T<sub>A</sub> = 25°C)

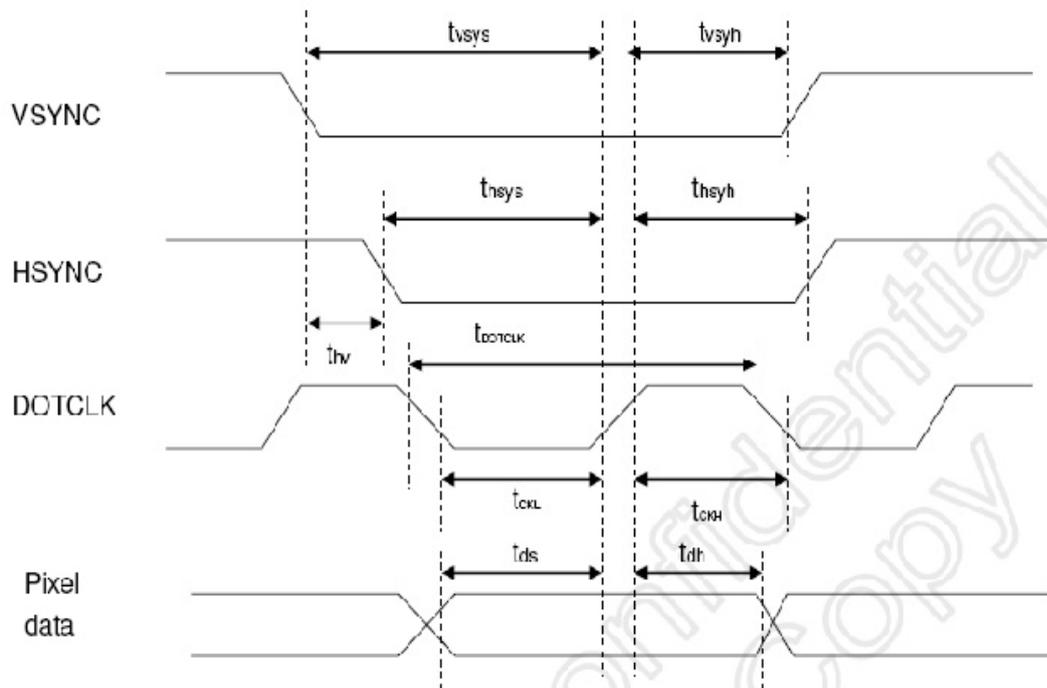

Figure 14. 1 Pixel timing

Characteristics	Symbol	Min		Typ		Max		Unit
		24 bit	8 bit	24 bit	8 bit	24 bit	8 bit	
DOTCLK Frequency	fDOTCLK	-	-	6.5	19.5	10	30	MHz
DOTCLK Period	tDOTCLK	100	33.3	154	51.3	-	-	ns
Vertical Sync Setup Time	tvsys	20	10	-	-	-	-	ns
Vertical Sync Hold Time	tsyn	20	10	-	-	-	-	ns
Horizontal Sync Setup Time	tsvs	20	10	-	-	-	-	ns
Horizontal Sync Hold Time	tshs	20	10	-	-	-	-	ns
Phase difference of Sync Signal Falling Edge	thv	1	-	-	-	240	-	tDOTCLK
DOTCLK Low Period	tCKL	50	15	-	-	-	-	ns
DOTCLK High Period	tCKH	50	15	-	-	-	-	ns
Data Setup Time	tds	12	10	-	-	-	-	ns
Data hold Time	tdlh	12	10	-	-	-	-	ns
Reset pulse width	tRES	-	10	-	-	-	-	us

Note: External clock source must be provided to DOTCLK pin of HX8238-A. The driver will not operate if absent of the clocking signal.

Table 14. 1 Pixel timing

Date : Oct. 03, 2007

TECHNICAL SPECIFICATION

**HYES**

LCM

HT3503L-T

Page 10 of 23

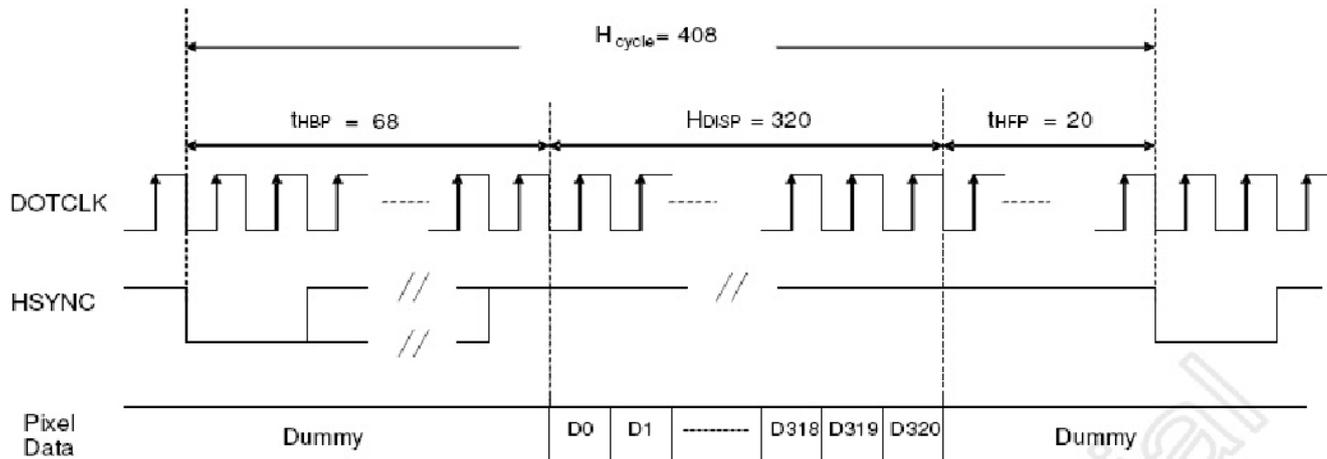

a) Horizontal Data Transaction Timing

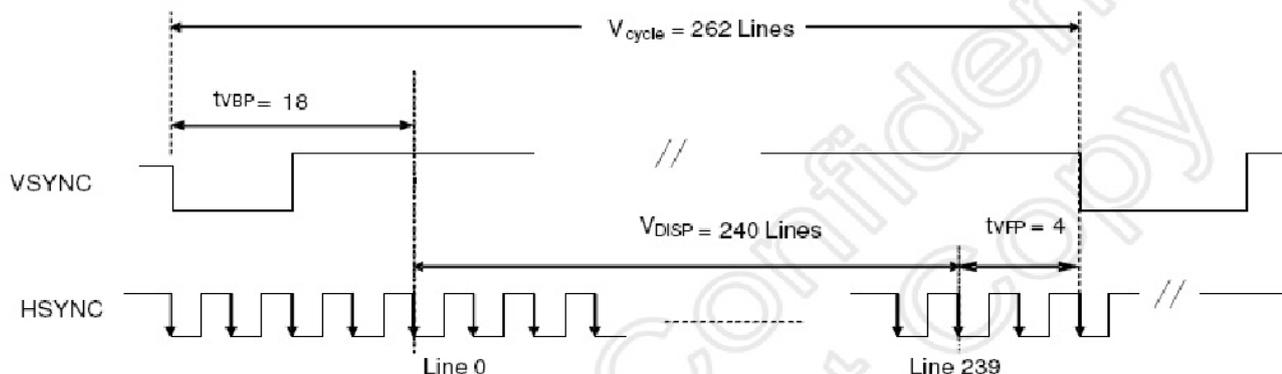

b) Vertical Data Transaction Timing

Figure 14. 2 Data transaction timing in parallel RGB (24 bit) interface (SYNC mode)

Characteristics	Symbol	Min		Typ		Max		Unit
		24 bit	8 bit	24 bit	8 bit	24 bit	8 bit	
DOTCLK Frequency	fDOTCLK	-	-	55	105	30	30	MHz
DOTCLK Period	1/fDOTCLK	180	18.1	18.1	51.9	-	-	ns
Horizontal Frequency (Line)	fH	-	-	14.9	-	21.35	-	KHz
Vertical Frequency (Refresh)	fV	-	-	60	-	60	-	Hz
Horizontal Back Porch	tHBP	-	-	68	204	-	-	DOTCLK
Horizontal Front Porch	tHFP	-	-	20	60	-	-	DOTCLK
Horizontal Data Start Point	tHDP	-	-	68	204	-	-	DOTCLK
Horizontal Blanking Period	tHBP + tHFP	-	-	88	264	-	-	DOTCLK
Horizontal Display Area	tHDP	-	-	320	960	-	-	DOTCLK
Horizontal Cycle	Hcycle	-	-	408	1224	430	1350	DOTCLK
Vertical Back Porch	tVBP	-	-	18	-	-	-	Lines
Vertical Front Porch	tVFP	-	-	4	-	-	-	Lines
Vertical Data Start Point	tVDP	-	-	18	-	-	-	Lines
Vertical Blanking Period	tVBP + tVFP	-	-	22	-	-	-	Lines
Vertical Display Area	NDISP			240				Lines
	PD			240(240/0.8)				
Vertical Cycle	NDCY			262				Lines
	PD			262		250		

Table 14. 2 Data transaction timing in normal operating mode

Date : Oct. 03, 2007

TECHNICAL SPECIFICATION

**HYES**

LCM

HT3503L-T

Page 11 of 23

### 3. OPTICAL CHARACTERISTICS

#### 3.1 Characteristics

Electrical and Optical Characteristics

No.	Item	symbol / temp.	Min.	Typ.	Max.	Unit	Note	
1	Response Time	Tr	25 °C	-	15	ms	2	
		Tf	25 °C	-	35			50
2	Viewing Angle	Front-Rear	$\Theta 1$	$\Phi =$	-15	-	degree	3
		Left-Right	$\Theta 2$	270°	-45	-		
3	Contrast Ratio	Cr	25 °C	150	250	-	-	4
4	Red x-code	Rx	25 °C	0.40	0.45	0.50	-	5
	Red y-code	Ry		0.31	0.36	0.41		
	Green x-code	Gx		0.25	0.30	0.35		
	Green y-code	Gy		0.37	0.42	0.47		
	Blue x-code	Bx		0.10	0.15	0.20		
	Blue y-code	By		0.06	0.11	0.16		
	White x-code	Wx		0.24	0.29	0.34		
	White y-code	Wy		0.26	0.31	0.36		
	Brightness	Y		200	250	-		
5	Brightness Uniformity		25 °C	80	-	-	%	6

Date : Oct. 03, 2007

TECHNICAL SPECIFICATION

**HYES**

LCM

HT3503L-T

Page 12 of 23

### 3.2 Definition of optical characteristics

#### Measurement condition :

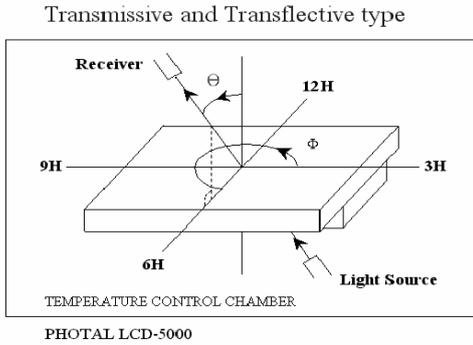

#### [Note 1] Definition of LCD Driving Vop and Waveform :

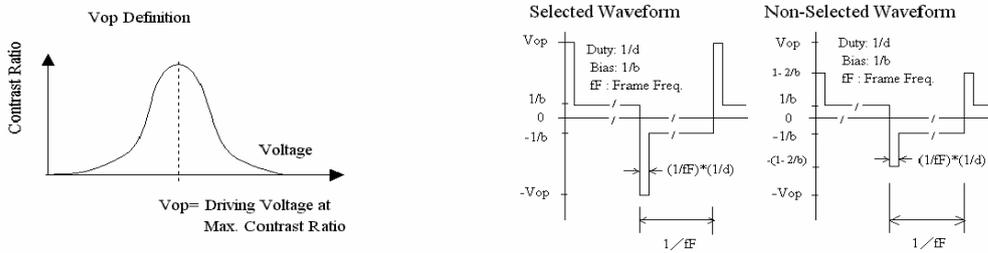

#### [Note 2] Definition of Response Time

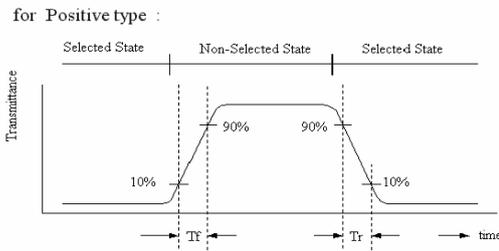

#### [Note 3] Definition of Viewing Angle :

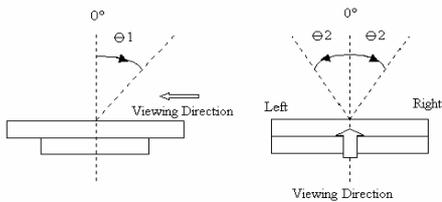

#### [Note 4] Definition of Contrast Ratio :

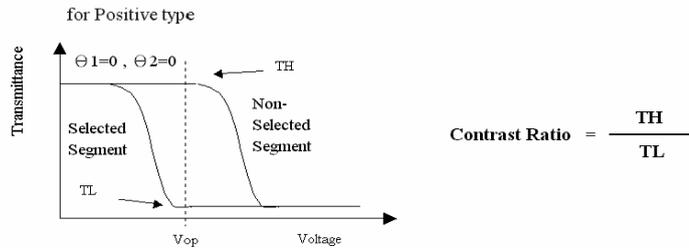

**[Note 5] Definition of measurement of Color Chromaticity and Brightness**

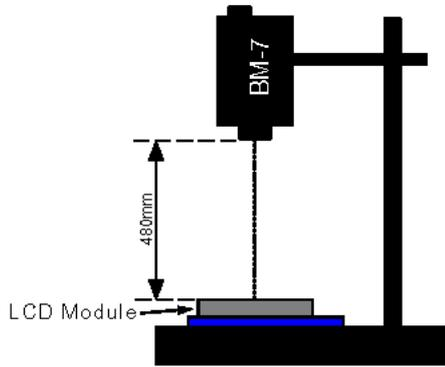

**[Note 6] Definition of Brightness Uniformity**

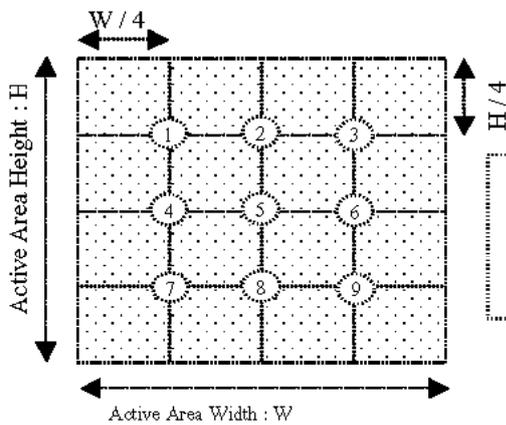

$$\text{Brightness Uniformity} = \frac{\text{Minimum Brightness of Point 1~9}}{\text{Maximum Brightness of Point 1~9}}$$

**[Note 7] Definition of Measurement of Reflectance**

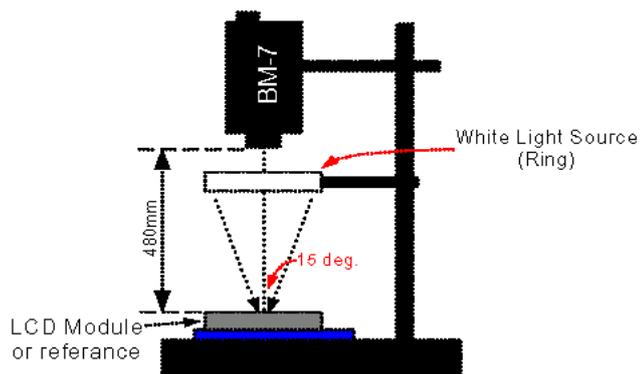

#### 4. RELIABILITY :

Item No	Items	Condition	Remark
1	High temperature operating	70 °C , 200 hours	Finish product (With polarizer)
2	Low temperature operating	-20 °C , 200 hours	Finish product (With polarizer)
3	High temperature storage	80 °C , 200 hours	Finish product (With polarizer)
4	Low temperature storage	-30 °C , 200 hours	Finish product (With polarizer)
5	High temperature & humidity storage	60°C, 90%RH, 100 hours	Finish product (With polarizer)
6	Thermal Shock storage	-30°C, 30min.<=> 80°C, 30min. 10 Cycles	Finish product (With polarizer)
7	Vibration test	10 => 55 =>10 => 55 => 10 Hz , within 1 minute Amplitude : 1.5mm. 15 minutes for each Direction ( X,Y,Z )	Finish product (With polarizer)
8	Drop test	Packed, 100CM free fall, 6 sides, 1 corner, 3edges	Finish product (With polarizer)
9	Life time	50,000 hours 25°C , 70%RH below , specification condition driving	Finish product (With polarizer)

- \* One single product test for only one item.
- \* Judgment after test : keep in room temperature for more than 2 hours.
  - Current consumption < 2 times of initial value
  - Contrast > 1/2 initial value
  - Function : work normally

Date : Oct. 03, 2007

TECHNICAL SPECIFICATION

**HYES**

LCM

HT3503L-T

Page 15 of 23

## 5. PRODUCT HANDING AND APPLICATION

### PRECAUTION FOR HANDLING LCM

- The LCD module contains a C-MOS LSI. People who operate the LCM should wear ESD protection equipment to prevent ESD hurt on products.
- Do not input any signal before power is turned on.
- Do not take LCM from its packaging bag until it is assembled.
- Peel off the LCM protective film slowly since static electricity may be generated.
- Pay attention to the humidity of the work shop, 50~60%RH is satisfactory.
- Use a non-leak iron for soldering LCM.
- Do not touch the display surface or connection terminals area with bare hands. Smudges on the display surface reduce the insulation between terminals.
- Cautions for soldering to LCM:  
 Condition for soldering I/O terminals:  
 Temperature at iron tip :280°C±10°C.  
 Soldering time : 3~4sec./ terminals.  
 Type of solder : Eutectic solder(rosin flux filled).

### PRECAUTION IN USE OF LCD

- Do not contact or scratch the front surface and the contact pads of a LCD panel with hard materials such as metal or glass or with one's nail.
- To clean the surface , wipe it gently with soft cloth dampened by alcohol.
- Do not attempt to wipe off the contact pads.
- Keep LCD panels away from direct sunlight , also avoid them in high-temperature & high humidity environment for a long period.
- Do not drive LCD panels by DC voltage.
- Do not expose LCD panels to organic solvent.
- Liquid in LCD is hazardous substance. In case a contact with liquid crystal material is occurred, be sure to immediately wash such material away by soap and water.
- The polarizer is easily damaged and should be handle with special care. Don't press or rub it with hard objects.

### PRECAUTION FOR STORING LCM

- To avoid degradation of the device , do not store the module under the conditions of direct sunlight , high temperature or high humidity . Keep the module in bags designed to prevent static electricity charging under low temperature / normal humidity conditions(avoid high temperature / high humidity and low temperature below 0°C)

### USING ON MEDICAL CARE , SAFETY OR HAZARDOUS APPLICATION OR SYSTEM

- For the application in medical care, safety and hazardous products or systems, an authorization from HYES is required. HYES will not responsible for any damage or loss which caused by the products without any authorization given by HYES.
- This product is not allowed to be designed and used for military application and/or purpose.
- The delivery of this product to the countries and/or regions where the embargoes are imposed by U.N. is prohibited.

Date : Oct. 03, 2007

TECHNICAL SPECIFICATION

**HYES**

LCM

HT3503L-T

Page 16 of 23



## 6. DATE CODE OF PRODUCTS

- Date code will be shown on each product :

- **Y MM DD - XXX**

Year Month Day - Production lots

- Example: 2 1 2 2 3 - 0 0 3 ==> Year 2002, Dec.,23rd , Batch no.03



**NOTE:**

T.B.D pcs / Tray  
 T.B.D Tray / Box  
 T.B.D Box / Carton  
 T.B.D pcs / Carton

- (1) Be warned, the direction of the tray has to turn it by 180 degree before stack it up. Otherwise, it will be packager's responsibility!!
- (2) Safe Stack : 5 cartons only

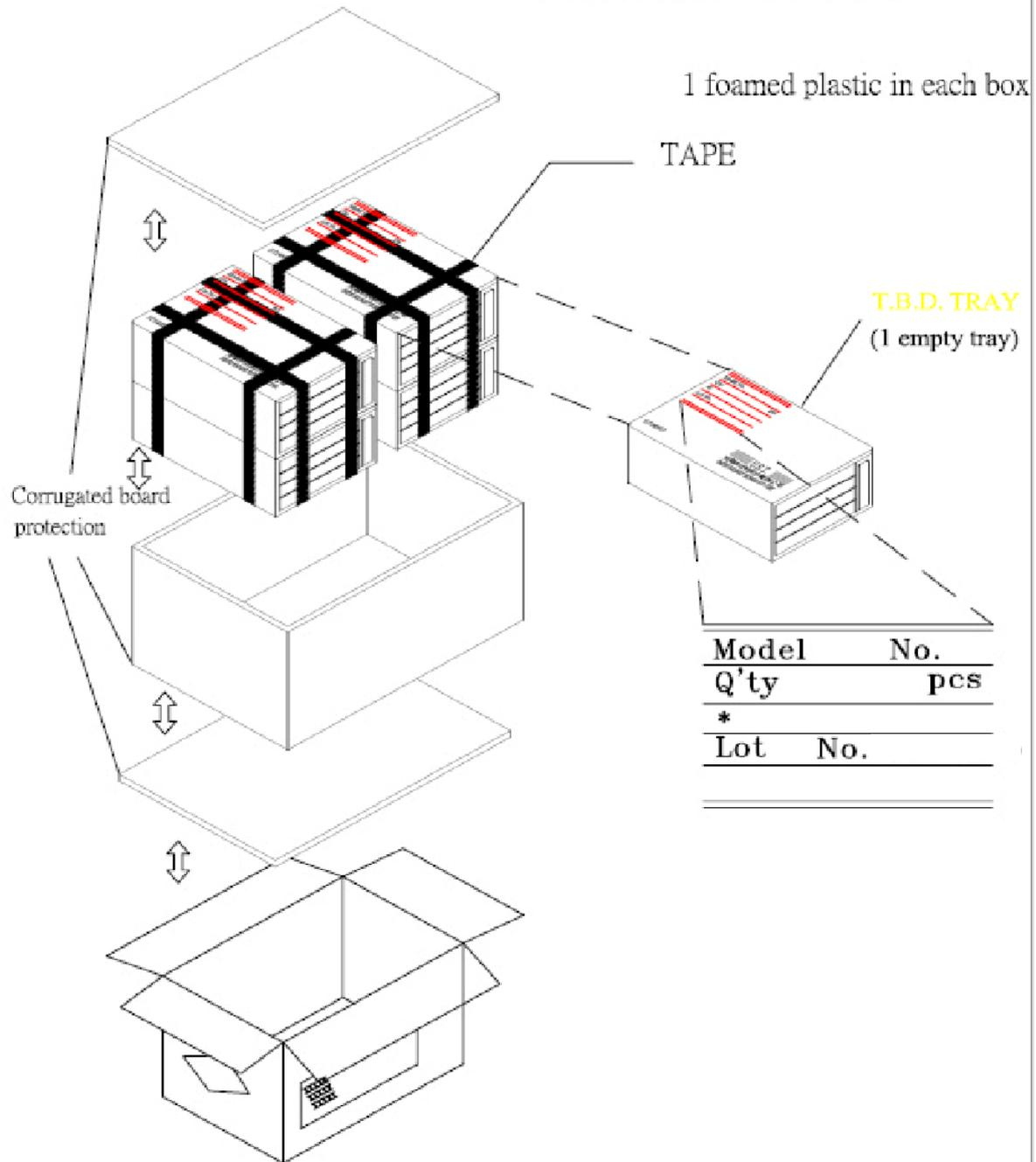

Date : Oct. 03, 2007

TECHNICAL SPECIFICATION

**HYES**

LCM

HT3503L-T

Page 19 of 23

## 8. INSPECTION STANDARD

### 8.1. QUALITY :

THE QUALITY OF GOODS SUPPLIED TO PURCHASER SHALL COME UP TO THE FOLLOWING STANDARD.

#### 8.1.1. THE METHOD OF PRESERVING GOODS

AFTER DELIVERY OF GOODS FROM **HYES** TO PURCHASER. PURCHASER SHALL CONTROL THE LCM AT -10 °C ~ 40 °C ,AND IT MIGHT BE DESIRABLE TO KEEP AT THE NORMAL ROOM TEMPERATURE AND HUMIDITY UNTIL INCOMING INSPECTION OR THROWING INTO PROCESS LINE.

#### 8.1.2. INCOMING INSPECTION

##### (A) THE METHOD OF INSPECTION

IF PURCHASER MAKE AN INCOMING INSPECTION , A SAMPLING PLAN SHALL BE APPLIED ON THE CONDITION THAT QUALITY OF ONE DELIVERY SHALL BE REGARDED AS ONE LOT.

##### (B) THE STANDARD OF QUALITY

ISO-2859-1 ( or MIL-STD-105D ), LEVEL II SINGLE PLAN.

CLASS	AQL(%)
CRITICAL	0.4 %
MAJOR	0.65 %
MINOR	1.5 %
TOTAL	1.5 %

EVERY ITEM SHALL BE INSPECTED ACCORDING TO THE CLASS.

##### (C) MEASURE

IF AS THE RESULT OF ABOVE RECEIVING INSPECTION , A LOT OUT IS DISCOVERED.

PURCHASER SHALL BE INFORM SELLER OF IT WITHIN SEVEN DAYS. BUT FIRST SHIPMENT WITHIN FOURTEEN DAYS.

#### 8.1.3. WARRANTY POLICY

**HYES** WILL PROVIDE ONE-YEAR WARRANTY FOR THE PRODUCTS ONLY IF UNDER SPECIFICATION OPERATING CONDITIONS. **HYES** WILL REPLACE NEW PRODUCTS FOR THESE DEFECT PRODUCTS WHICH UNDER WARRANTY PERIOD AND BELONG TO THE RESPONSIBILITY OF **HYES**.

## 8.2. CHECKING CONDITION

8.2.1. CHECKING DIRECTION SHALL BE IN THE 45 DEGREE AREA TO FACE THE SAMPLE.

8.2.2. CHECKER SHALL SEE OVER 30 cm. WITH BARE EYES FAR FROM SAMPLE AND USING 2 PCS. OF 20W FLUORESCENT LAMP.

Date : Oct. 03, 2007

TECHNICAL SPECIFICATION

**HYES**

LCM

HT3503L-T

Page 20 of 23

**8.3. INSPECTION PLAN :**

CLASS	ITEM	JUDGEMENT	CLASS
PACKING & INDICATE	1. OUTSIDE AND INSIDE PACKAGE	"MODEL NO." , "LOT NO." AND "QUANTITY" SHOULD INDICATE ON THE PACKAGE.	Minor
	2. MODEL MIXED AND QUANTITY	OTHER MODEL MIXED.....REJECTED QUANTITY SHORT OR OVER.....REJECTED	Critical
	3. PRODUCT INDICATION	"MODEL NO." SHOULD INDICATE ON THE PRODUCT	Major
ASSEMBLY	4. DIMENSION, LCD GLASS SCRATCH AND SCRIBE DEFECT.	ACCORDING TO SPECIFICATION OR DRAWING.	Major
APPEARANCE	5. VIEWING AREA	POLARIZER EDGE OR LCD'S SEALING LINE IS VISABLE IN THE VIEWING AREA .....REJECTED	Minor
	6. BLEMISH - BLACK SPOT - WHITE SPOT IN THE LCD AND LCD GLASS CRACKS	ACCORDING TO STANDARD OF VISUAL INSPECTION ( INSIDE VIEWING AREA )	Minor
	7. BLEMISH - BLACK SPOT WHITE SPOT AND SCRTCH ON THE POLARIZER	ACCORDING TO STANDARD OF VISUAL INSPECTION ( INSIDE VIEWING AREA )	Minor
	8. BUBBLE IN POLARIZER	ACCORDING TO STANDARD OF VISUAL INSPECTION ( INSIDE VIEWING AREA )	Minor
	9. LCD'S RAINBOW COLOR	STRONG DEVIATION COLOR ( OR NEWTON RING) OF LCD.....REJECTED. OR ACCORDING TO LIMITED SAMPLE ( IF NEEDED, AND INSIDE VIEWING AREA )	Minor
ELECTRICAL	10. ELECTRICAL AND OPTICAL CHARACTERISTICS ( CONTRAST - VOP - CHROMATICITY ... ETC )	ACCORDING TO SPECIFICATION OR DRAWING . ( INSIDE VIEWING AREA )	Critical
	11. MISSING PATTERN	MISSING DOT - LINE - CHARACTER .....REJECTED	Critical
	12. SHORT CIRCUIT - WRONG PATTERN DISPLAY	NON DISPLAY - WRONG PATTERN DISPLAY - CURRENT CONSUMPTION OUT OF SPECIFICATION..... REJECTED	Critical
	13. PIN HOLE - PATTERN DEFORMITY	ACCORDING TO STANDARD OF VISUAL INSPECTION	Minor

Date : Oct. 03, 2007

TECHNICAL SPECIFICATION

**HYES**

LCM

HT3503L-T

Page 21 of 23

### 8.4. STANDARD OF VISUAL INSPECTION

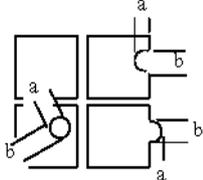
NO.	CLASS	ITEM	JUDGEMENT																									
8.4.1	MINOR	<ul style="list-style-type: none"> <li>· BLEMISH · BLACK SPOT · WHITE SPOT IN THE LCD.</li> <li>· BLEMISH · BLACK SPOT · WHITE SPOT AND SCRATCH ON THE POLARIZER</li> </ul>	<p>(A) ROUND TYPE: <span style="float: right;">unit : mm.</span></p> <table border="1"> <thead> <tr> <th>DIAMETER (mm.)</th> <th>ACCEPTABLE Q'TY</th> </tr> </thead> <tbody> <tr> <td><math>\Phi \leq 0.1</math></td> <td>DISREGARD</td> </tr> <tr> <td><math>0.1 &lt; \Phi \leq 0.2</math></td> <td>2</td> </tr> <tr> <td><math>0.2 &lt; \Phi \leq 0.25</math></td> <td>1</td> </tr> <tr> <td><math>0.25 &lt; \Phi</math></td> <td>0</td> </tr> </tbody> </table> <p>NOTE: <math>\Phi = (\text{LENGTH} + \text{WIDTH}) / 2</math></p> <p>(B) LINER TYPE: <span style="float: right;">unit : mm.</span></p> <table border="1"> <thead> <tr> <th>LENGTH</th> <th>WIDTH</th> <th>ACCEPTABLE Q'TY</th> </tr> </thead> <tbody> <tr> <td>-----</td> <td><math>W \leq 0.03</math></td> <td>DISREGARD</td> </tr> <tr> <td><math>L \leq 5.0</math></td> <td><math>0.03 &lt; W \leq 0.05</math></td> <td>3</td> </tr> <tr> <td><math>L \leq 5.0</math></td> <td><math>0.05 &lt; W \leq 0.07</math></td> <td>1</td> </tr> <tr> <td>-----</td> <td><math>0.07 &lt; W</math></td> <td>FOLLOW ROUND TYPE</td> </tr> </tbody> </table>	DIAMETER (mm.)	ACCEPTABLE Q'TY	$\Phi \leq 0.1$	DISREGARD	$0.1 < \Phi \leq 0.2$	2	$0.2 < \Phi \leq 0.25$	1	$0.25 < \Phi$	0	LENGTH	WIDTH	ACCEPTABLE Q'TY	-----	$W \leq 0.03$	DISREGARD	$L \leq 5.0$	$0.03 < W \leq 0.05$	3	$L \leq 5.0$	$0.05 < W \leq 0.07$	1	-----	$0.07 < W$	FOLLOW ROUND TYPE
DIAMETER (mm.)	ACCEPTABLE Q'TY																											
$\Phi \leq 0.1$	DISREGARD																											
$0.1 < \Phi \leq 0.2$	2																											
$0.2 < \Phi \leq 0.25$	1																											
$0.25 < \Phi$	0																											
LENGTH	WIDTH	ACCEPTABLE Q'TY																										
-----	$W \leq 0.03$	DISREGARD																										
$L \leq 5.0$	$0.03 < W \leq 0.05$	3																										
$L \leq 5.0$	$0.05 < W \leq 0.07$	1																										
-----	$0.07 < W$	FOLLOW ROUND TYPE																										
8.4.2	MINOR	BUBBLE IN POLARIZER	<p style="text-align: right;">unit : mm.</p> <table border="1"> <thead> <tr> <th>DIAMETER</th> <th>ACCEPTABLE Q'TY</th> </tr> </thead> <tbody> <tr> <td><math>\Phi \leq 0.15</math></td> <td>DISREGARD</td> </tr> <tr> <td><math>0.15 &lt; \Phi \leq 0.5</math></td> <td>2</td> </tr> <tr> <td><math>0.5 &lt; \Phi</math></td> <td>0</td> </tr> </tbody> </table>	DIAMETER	ACCEPTABLE Q'TY	$\Phi \leq 0.15$	DISREGARD	$0.15 < \Phi \leq 0.5$	2	$0.5 < \Phi$	0																	
DIAMETER	ACCEPTABLE Q'TY																											
$\Phi \leq 0.15$	DISREGARD																											
$0.15 < \Phi \leq 0.5$	2																											
$0.5 < \Phi$	0																											
8.4.3	MINOR	PIN HOLE · PATTERN DEFORMITY	<div style="display: flex; align-items: center;">  <table border="1" style="margin-left: 20px;"> <thead> <tr> <th colspan="2">DIAMETER</th> <th>ACC. Q'TY</th> </tr> </thead> <tbody> <tr> <td><math>\Phi \leq 0.1</math></td> <td></td> <td>DISREGARD</td> </tr> <tr> <td><math>0.1 &lt; \Phi \leq 0.25</math></td> <td></td> <td>3</td> </tr> <tr> <td><math>0.25 &lt; \Phi</math></td> <td></td> <td>0</td> </tr> </tbody> </table> </div> <p style="text-align: center;"><math>\Phi = (a+b)/2</math></p> <p style="text-align: right;">unit : mm.</p>	DIAMETER		ACC. Q'TY	$\Phi \leq 0.1$		DISREGARD	$0.1 < \Phi \leq 0.25$		3	$0.25 < \Phi$		0													
DIAMETER		ACC. Q'TY																										
$\Phi \leq 0.1$		DISREGARD																										
$0.1 < \Phi \leq 0.25$		3																										
$0.25 < \Phi$		0																										

Date : Oct. 03, 2007

TECHNICAL SPECIFICATION

**HYES**

LCM

HT3503L-T

Page 22 of 23

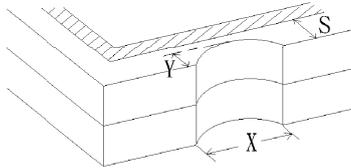
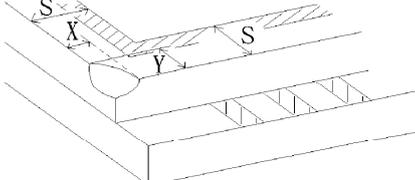
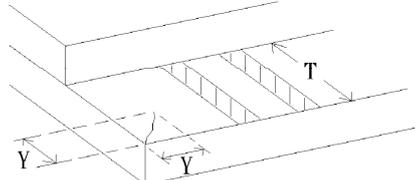
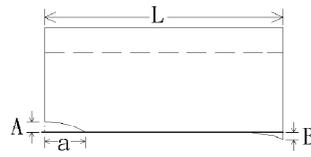
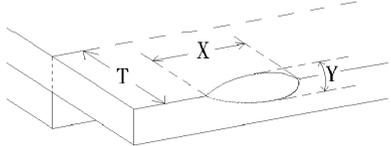
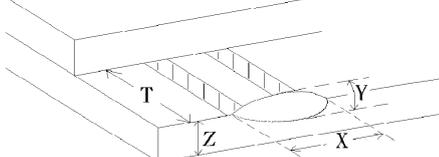
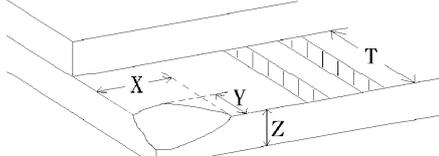
NO.	CLASS	ITEM	JUDGEMENT
8.4.4	MINOR	CHIPPING	 <p style="text-align: right;"><math>Y &gt; S</math></p> <p style="text-align: right;">REJ.</p>
8.4.5	MINOR	CHIPPING	 <p style="text-align: right;"><math>X \text{ or } Y &gt; S</math></p> <p style="text-align: right;">REJ.</p>
8.4.6	MAJOR	GLASS CRACK	 <p style="text-align: right;"><math>Y &gt; (1/2) T</math></p> <p style="text-align: right;">REJ.</p>
8.4.7	MAJOR	SCRIBE DEFECT	 <p style="text-align: right;">1. <math>a &gt; L/3</math>, <math>A &gt; 1.5\text{mm}</math>. REJ.</p> <p style="text-align: right;">2. B : ACCORDING TO DIMENSION</p>
8.4.8	MINOR	CHIPPING ( ON THE TERMINAL AREA )	 <p style="text-align: right;"><math>\Phi = (x+y)/2 &gt; 2.5 \text{ mm}</math></p> <p style="text-align: right;">REJ.</p>
8.4.9	MINOR	CHIPPING ( ON THE TERMINAL SURFACE )	 <p style="text-align: right;"><math>Y &gt; (1/3) T</math></p> <p style="text-align: right;">REJ.</p>
8.4.10	MINOR	CHIPPING	 <p style="text-align: right;"><math>Y &gt; T</math></p> <p style="text-align: right;">REJ.</p>

Date : Oct. 03, 2007

TECHNICAL SPECIFICATION

**HYES**

LCM

HT3503L-T

Page 23 of 23